



Load Restraint Guidelines

QENOS SUPPLY CHAIN

CoRsafe

1 Contents

2	About this document	3
3	Introduction - Load restraint laws in Australia	4
4	References	4
5	Why do I need to restrain my load?.....	5
5.1	To be safe.....	5
5.2	It is good for business	5
5.3	Unrestrained loads will move	5
5.4	To comply with the Law	5
5.5	Tie-down lashings	6
6	Performance standards.....	6
7	Qenos Load Restraint Guidelines.....	8
7.1	Less-than-full loads	8
7.2	Load restraint.....	10
7.3	Loads on pallets	16
7.4	Pantechs.....	17
7.5	Intermediate Bulk Containers (IBCs).....	17
7.6	Bulk bags	18
7.7	Drums.....	19
7.8	Bags and Sacks	20
7.9	Stillages and transport frames.....	21
7.10	Contained Loads.....	22
7.11	Containerised freight	23
7.12	Bladders, liners and flexible tanks	24
7.13	Bulk loads.....	25
7.14	Machinery and Equipment.....	26
7.15	Vehicles and Mobile Equipment	26
7.16	Dangerous Goods.....	28
8	Document control register.....	29
9	Further Information	29

ISSUE COPYRIGHT - APPROVED USE ONLY

2 About this document

This guideline supports the successful implementation of the LSS CoRsafe system within the Qenos Supply Chain.

It summarises key elements of Australian road transport regulation as it applies to load restraint, focusing on those areas which were identified as key elements of the Qenos Supply Chain.

This guide seeks to communicate the expectations of how Qenos requires load restraint to be undertaken by its supply chain partners, however:

You don't have to do it this way, but you do have to get approval before doing it another way

It may be possible to meet load restraint requirements by other means, if you wish to propose alternative approaches to load restraint, contact Qenos. Alternative methods will need to be certified by an appropriately qualified engineer and approved by Qenos prior to being used.

This guideline is not the only thing you may need to consider

There may be other legal requirements in addition to those within this guide, you must comply with all legal requirements at all times while performing any role within the Qenos supply chain. If you believe a requirement applies which conflicts with the requirements of this guideline, contact Qenos.

It is not legal advice, consider getting your own

This guideline must not be relied upon as legal advice, it only considers information as provided by Qenos, it does not consider the individual circumstances of any other party in the Qenos supply chain. As part of managing risk within the CoRsafe system, you are required to keep yourself informed about any processes you influence or control.

Things will change, this document may not

This material is provided at a point in time and is only updated when requested by Qenos. Legislation and regulations will change, and this change may not necessarily be reflected in this document. Use only the version held on the LSS CoRsafe platform, any other copies (whether electronic or hard copy) are uncontrolled and must not be used.

3 Introduction - Load restraint laws in Australia

These Load Restraint procedures are an attachment to the LSS CoR Standard for the Qenos supply chain and are the minimum service requirement for this supply chain (Note - Approved alternatives are possible – refer to the LSS CoR Standard for conditions).

Load Restraint laws in Australia require that all loads on commercial vehicles are restrained properly. Chain of responsibility provisions of the HVNL and Western Australian law apply to load restraint, so that all parties who influence load restraint may be liable to prosecution if they fail to eliminate or effectively manage risk.

Your legal responsibilities:

- **You are legally responsible** for restraining your load so that:
 - **It does not come off your vehicle** under normal driving conditions, including heavy braking and minor collisions. If it comes off, this is evidence you have breached the law
 - **It does not negatively impact the stability of the vehicle**, which can cause the vehicle to roll over or swerve uncontrollably, and cause an accident
 - **It does not stick out of the vehicle** in a way that could injure people, damage property or obstruct others' path
- **You must pick up any fallen load** if it is safe to do so, or arrange for someone to retrieve it.

4 References

- NTC LR Guide” – The National Transport Commission (NTC) Load Restraint Guide 3rd Edition 2018
- Heavy Vehicle National Law (Section 111)
- Heavy Vehicle (Mass, Dimension and Loading) National Regulation (Schedule 7, 1 - Loading requirements)
- Australian Code for the Transport of Dangerous Goods by Road and Rail. Edition 7.4.

5 Why do I need to restrain my load?¹

5.1 To be safe

- Loads that aren't restrained properly can injure or kill and can cause significant property damage.
 - If the load falls off it **endangers the lives of other road users** through a direct collision or by causing other drivers to swerve to avoid it.
 - If the load moves forward it **can pierce the cabin and injure or kill the driver or passenger**.
 - If the load makes the vehicle unstable it can **cause an incident**, especially when taking corners.

5.2 It is good for business

- Your corporate reputation and your financial position can suffer if you're involved in a load restraint incident, due to:
 - adverse publicity in the press,
 - loss of contracts due to damaged goods,
 - insurance excess payments,
 - increase in insurance premiums

5.3 Unrestrained loads will move

- Forces from changes in speed, direction or slope will cause a load to shift.
- These forces result from normal driving conditions, including braking, accelerating, cornering, road surfaces and air flow.
- **The weight of a load will not hold it in place.**
 - A heavy load is just as likely to fall off as a light load because the heavier the load, the higher the forces it experiences.

5.4 To comply with the Law

- If you're involved in **packing, loading, moving or unloading a vehicle**, you are responsible for complying with load restraint laws.

¹ NTC Load Restraint Guide 2018 p 7

5.5 Tie-down lashings

- The number of tie-down lashings is dependent on a number of variables including but not limited to:
 - If the load is blocked or not
 - The friction between the truck tray/trailer and the load
 - The type and size (rating) of the lashing
 - The type of tensioner used e.g., truck winch, push-up hand ratchet or pull-down hand ratchet (in the case of webbing straps)
 - The lashing angle (angle effect)
 - The weight of the load
- There is a common misconception in the industry that a 2.5t rated webbing strap can restrain 2.5t of goods. Based on the variables above this is not always the case.

6 Performance standards

“Performance Standards” within the NTC Load Restraint Guide set out the minimum amount of force a restraint system must be able to withstand in each direction. If a load is restrained to meet these Performance Standards it will not fall off or move around on the vehicle under expected driving conditions. This includes emergency braking and minor collisions.

- 1) A load on a heavy vehicle must be restrained by a load restraint system that:
 - a) prevents the load from moving in relation to the heavy vehicle (other than movement allowed under subsection (2)) in the circumstances mentioned in subsection (3); and
 - b) at a minimum, is capable of withstanding the forces that would result in the circumstances mentioned in subsection (3).
- 2) A load may move in relation to a heavy vehicle if:
 - a) the vehicle’s stability and weight distribution are not adversely affected by the movement; and
 - b) the load does not become dislodged from the vehicle.

Examples of load movement that may be permitted under (2)

1. a load contained within the sides or enclosure of the heavy vehicle that is restrained from moving horizontally may be able to move vertically;
2. a load of very light objects, or a loose bulk load, that is contained within the sides or enclosure of the heavy vehicle may be able to move horizontally and vertically;
3. a bulk liquid load contained within the sides or enclosure of the heavy vehicle.

- 3) For subsection (1), the circumstances are that the loaded vehicle is subjected to:
- a) any of the following, separately:
 - i) 0.8 g deceleration in a forward direction;
 - ii) 0.5 g deceleration in a rearward direction;
 - iii) 0.5 g acceleration in a lateral direction; and
 - b) if friction or limited vertical displacement is relied on to comply with (a), 0.2 g acceleration in a vertical direction relative to the load.

Note: 'g' (the acceleration due to gravity), is equal to 9.81m/s² for the purpose of these standards.

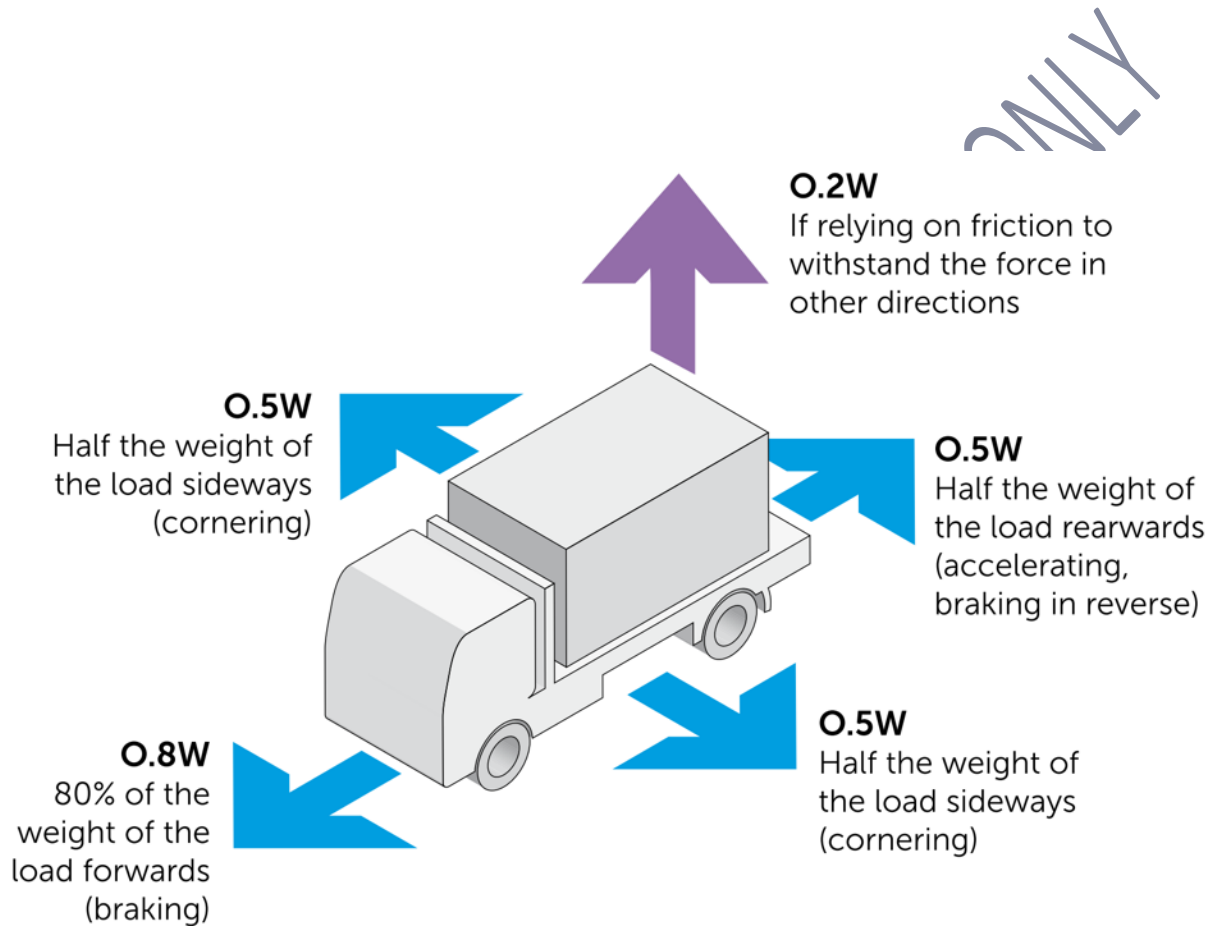

(W = weight of the load)

7 Qenos Load Restraint Guidelines

The “load types” for the majority of Qenos freight are:

- Containerised bulk plastic pellets
- Bulker bags and smaller product bags on pallets
- Bulk liquids including DG products
- LPG
- Large wax blocks on pallets
- Miscellaneous freight in stillages, skips, bins and tanks
- Miscellaneous freight on pallets
- Bulk loads of pallets
- Coal and coal ash
- Vehicles and mobile equipment
- Oversize loads of speciality equipment

The trailing equipment generally used for these load types are:

- Tautliners
- Container skels for cartage of containers and isotainers
- Flatbed trailers
- Pantech trailers
- Road Tankers
- LPG tankers
- Tippers and tipping trailers
- Shipping Containers
- Flat-bed trailers
- Bulk tankers

Loads may be either “full loads” or “less-than-full loads”. The following rules must be applied for the above:

7.1 Less-than-full loads

A less-than-full load is a load where there are cumulative gaps of more than 200 mm front to back or 100 mm side to side, between the load itself and either the front, back and/or side of the trailer, any of which can cause “sideways” and/or “forward/backward” movement of the load.

7.1.1 Side to side gaps

If the cumulative gap side to side is **greater than 100mm** (i.e. A+B below), then the load must either be restrained or the gap blocked.

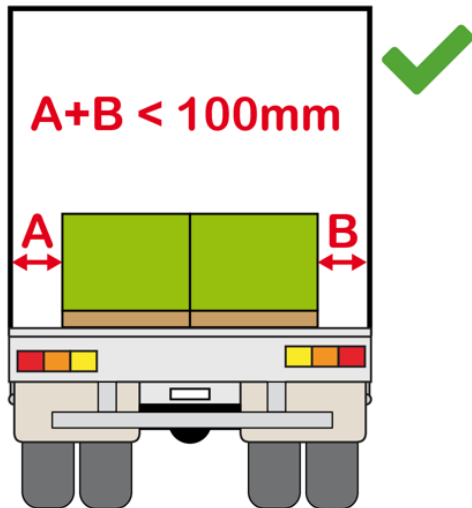

Where the cumulative gap (i.e. A+B) is **less than 100mm**

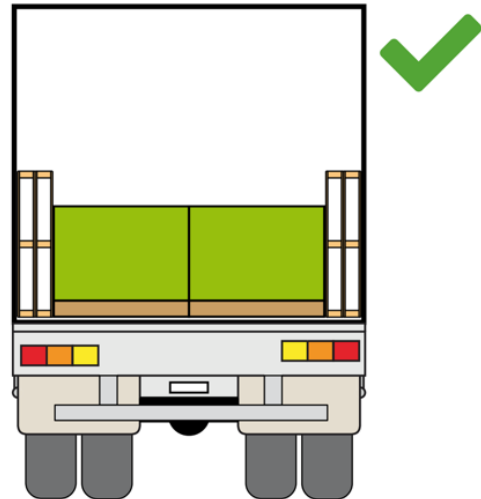

Blocking where the cumulative gap (i.e. A+B) is **greater than 100mm**

7.1.2 Front to back gaps

Where there is a cumulative gap of **greater than 200mm** between the load and the front and/or rear of the trailer, then the load must be restrained by the use of “blocking” and/or “tie-down with appropriately rated webbing and angles.

Examples of “blocking”



Only use shoring/blocking bars to stabilise loads because they have limited load restraint capacity. Rated bars may be suitable for blocking some loads.

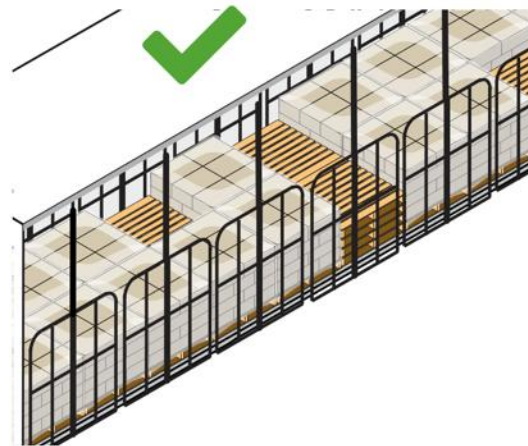

Pallets filling in gaps

Examples of “tie-down”



Locked blocked in forward direction and tied down for lateral and rearward restraint

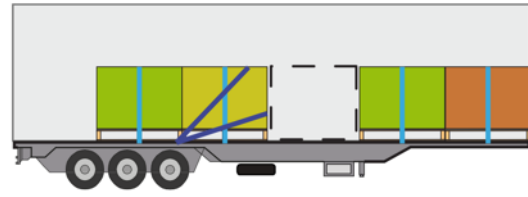

Additional tie-down due to loss of forward blocking with pallet removed

7.1.3 Vertical restraint

When a load is tied down and restrained using friction, it must also be restrained vertically to withstand a minimum force of 20% of its weight (i.e. $0.2W$); this stops it from shifting upwards (e.g. on rough roads) and keeps the load in contact with the vehicle throughout its journey.

7.2 Load restraint

7.2.1 Side gates

Side gates work as a containment solution providing sideways restraint. Side gates are either rated or unrated.

- **Rated side gates** have been tested for load restraint and certified to meet the forces in the Performance Standards (Refer to Section 6). Certification of rated side gates should specify details about the load that the gates can restrain, including size, shape, weight and packaging. Rated side gates will generally be attached to the vehicle, and have a mechanism to lock them in place when in use. Rated side gates form part of a load restraint system, generally in conjunction with rated load restraint curtains. Restraint capabilities of the system are to be described on the certification label affixed to the curtains, or the certification documentation which should be kept with the vehicle at all times.
- **Unrated side gates** have limited restraint capacity; they should be braced – that is, supported at the top by diagonal cross-lashings to the opposite tie rails, tied down, or attached to other structures such as bulk heads or loading racks.

7.2.1.1 Bracing of gates

Unrated side gates have limited restraint capacity; they should be braced – that is, supported at the top by diagonal cross-lashings to the opposite tie rails, tied down, or attached to other structures such as bulk heads or loading racks

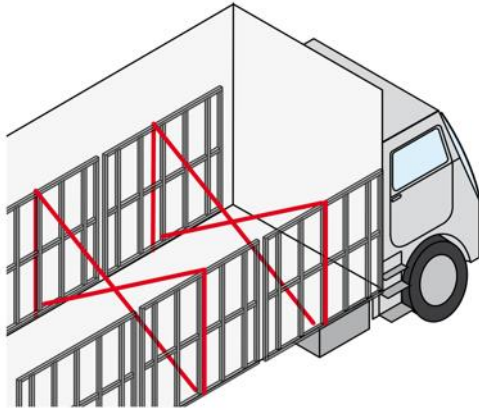

Gates lashed down – use for very lightweight loads only.

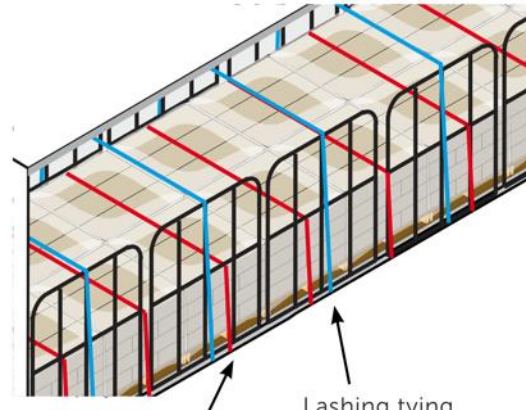

Combination of lashed gates **and** lashing to tie down the load

7.2.1.1 Load tie down

Other than when providing lateral restraint for very lightweight loads, when using **unrated** side gates, restrain the load using the gates **and** other restraints – i.e. by using tie-down or direct lashings, blocking and/or containment by other vehicle structures.

7.2.2 Side curtains

Side curtains are flexible sheets that are secured to the vehicle.

Unrated side curtains are used to provide weather-proofing.

Rated side curtains have been tested and certified to meet a certain level of load restraint for sideways forces.

7.2.2.1 Unrated side curtains

Use unrated side curtains to weather-proof the load and protect it from dust. The load must be restrained by other means to meet the performance standard.

7.2.2.2 Rated side curtains

Rated side curtains will have a certification label attached to them and/or a certification document. Certification should specify if gates are required to be used with the side curtains, as well as details about the load that the curtains can restrain, including size, shape, weight, and packaging.

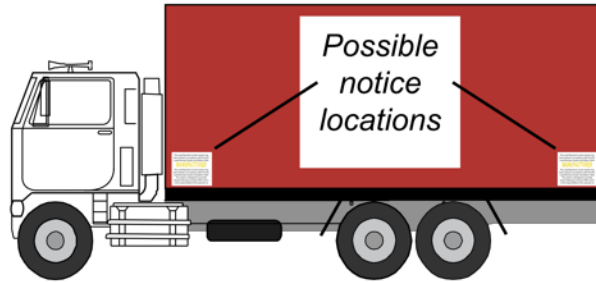

Use rated side curtains to provide effective sideways blocking for many load types, as specified on the certification (e.g. palletised goods, bulk loads, and lightweight full loads).

Load restraint curtains cannot be used alone; a compliant restraint system also requires methods for forward and rearward restraint, and additional sideways restraint may also be needed.

Make sure that there are no gaps in the load in the forward, rearward or sideward directions. If there are gaps in the load, block them with empty pallets or stillages to spread the load flat along the curtain.

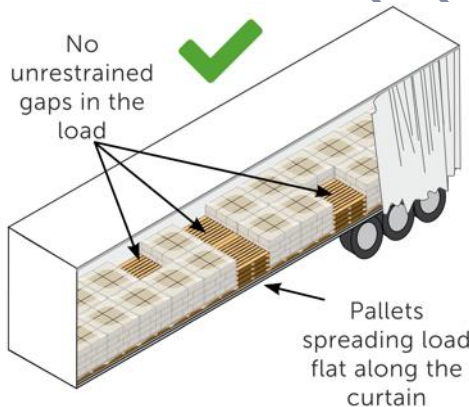

7.2.3 Webbing

Webbing is a lightweight restraint system used throughout the transport industry. Webbing assemblies include load-rated webbing material with specified stitching and sewing patterns, together with end fittings, tensioning devices, and a rating tag.

Webbing assemblies with either attached or in-line ratchet winches must comply with Australian Standard AS/NZS 4380 Motor vehicles – Cargo restraint systems – Transport webbing and components.

The lashing capacity is displayed on each assembly that complies with the relevant Australian Standard.

The lashing capacity of a webbing assembly does not equal the pretension force. Typical lashing capacity for a 50mm webbing strap is 2,000 kg, whereas pretension is only 300 kgf.

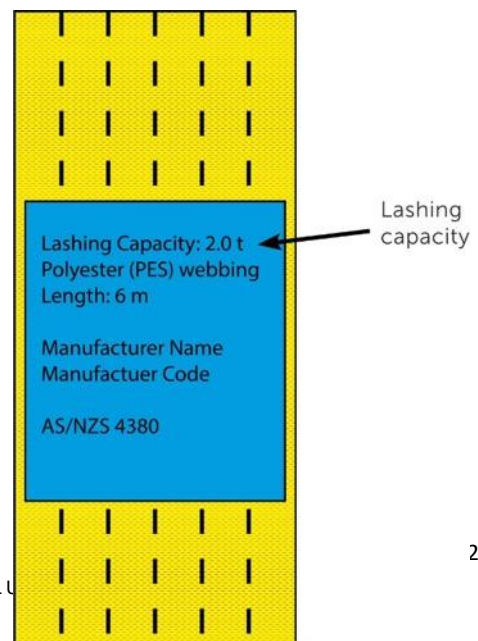

Do not use webbing assemblies that do not comply with AS 4380 for load restraint purposes because they can have much lower ratings.

Use webbing to restrain:

- palletised goods
- loads that can settle or deform during transport (e.g. bags and sacks)
- loads that can damage easily from lashings
- loads that don't have sharp edges.

Webbing is more elastic than chains or steel strapping. Webbing will retain some of its initial tension during transport if a load deforms slightly or settles.

Do not use webbing assemblies with chemicals or at high temperatures without referring to the manufacturer's instructions.

What to look for when using webbing

- Check there are no knots or twists in the strapping.
- While webbing straps should not be excessively twisted, a half-turn may help to prevent vibration and flapping.
- Check strapping is not attached to anchor points using knots.
- Look out for webbing that appears furry because this indicates the webbing is worn and can lead to broken load-bearing fibres.
- Look out for any damage caused by cuts and abrasions, particularly where the webbing contacts the load and the coaming rails.



Tensioning Webbing Straps

Webbing straps can be tensioned using either attached clip-on sliding winches, in-line tensioners or geared winches.

The amount of tension produced by a truck winch or hand ratchet depends on the length of the handle, how large the diameter of the webbing spool becomes during tightening, and the number of ratchet teeth.

Hand ratchets that operate by pulling the handle downwards will normally produce much more pretension (600 kgf) than push-up ratchets and standard truck winches (300 kgf).

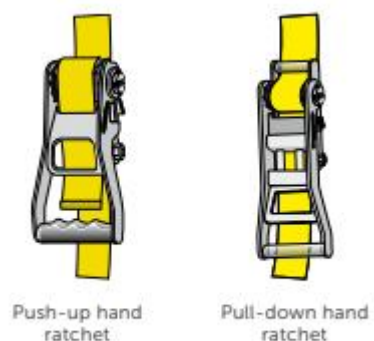

If a strap cannot be fully tensioned due to potential damage to freight, multiple straps may need to be used to ensure adequate load restraint.

Make sure the strapping is wound evenly across the drum of the winch or ratchet.

The effectiveness of the tensioner decreases significantly as the thickness of the layers of webbing increases.

During your journey, you should regularly check and re-tension your webbings as needed.

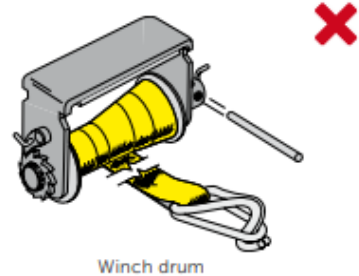

7.2.4 Chains

Transport chain is a highly durable lashing with low stretch characteristics. Chain used for load restraint should comply with AS/NZS 4344 Motor vehicles – Cargo restraint systems – Transport chain and components. Chains are secured using shortening hooks and chain tensioners.

Using Chain

- Used to restrain strong rigid loads that are not easily damaged, or where the product can be protected from contact damage
- Do not use chain to tie down loads that can crush or settle
- If needed, use corner protectors, sleeves or other material where lashings and loads contact each other
- Straighten out any twists in the chain, and ensure it is free of knots before tensioning
- Make sure chain is attached to anchor points using appropriate hooks
- Monitor chain tension, as hooks can become uncoupled if the chain slackens when the load settles during a journey.
- Inspect chain before use, and discard if it is stretched or damaged in any way



Using Hooks

- There are two types of shortening hooks, grab hooks, and claw hooks
- Always use hooks that match the size of the chain
- Use winged grab hooks where possible as they prevent the chain link from bending

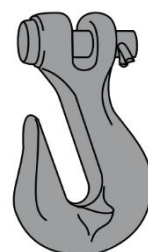

Using Chain Tensioners

- Use turnbuckles or ratchet type tensioners to tension chains
- Turnbuckles are screw tensioners operated by a ratchet or lever, and have no kickback when released
- Make sure the turnbuckle can rotate freely when tightening
- Use of over-centre tensioners (dogs) is strongly discouraged, due to the potential for kick back when released. Use alternative chain tensioners whenever possible

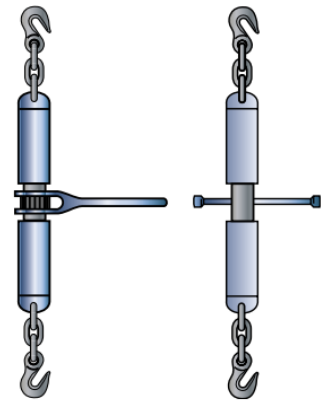

7.2.5 Stretch and Shrink Wrapping

Use stretch or shrink film wrapping to consolidate multiple product items into one pack, making them more stable and easier to restrain. Wrapping will also protect products from the elements.

Wrapping may form part of a load restraint system provided it is of sufficient strength, or sufficiently layered.

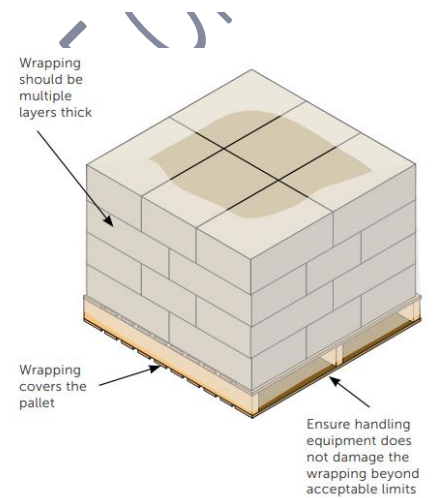

Using wrapping

- Make sure the wrapping is multiple layers thick to sufficiently unitise and protect the product from damage
- The number of wrapping layers required depends on the weight and interlayer friction of the product
- Extend the wrapping to include the pallet if unitising loads with low-friction layers

7.2.6 Wrapping Wax Blocks

Up to two wax blocks may be transported on a single pallet. The wax blocks must be unitised together and to the pallet by the use of stretch wrap.

The stretch wrap must be of sufficient strength, and applied in sufficient layers to ensure both blocks are unitised and cannot separate during transport.

Stretch wrapping must extend downwards to include the pallet, and must be of sufficient strength to contain the wax block to the pallet.



7.3 Loads on pallets

To simplify restraint requirements, unitise items placed on pallets to the pallet itself. Make sure the unitising sufficiently secures all items to the pallet during transport. Ensure the pallet is in serviceable condition, and fit for purpose.

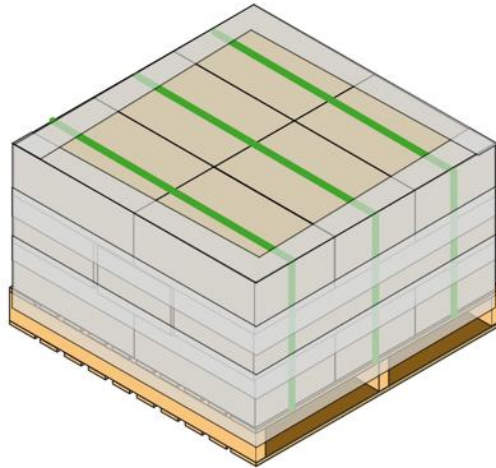

Apply additional restraint or contain pallets if items can dislodge. Items can dislodge from the pallet if the load is uncontained and the items are not sufficiently unitised.

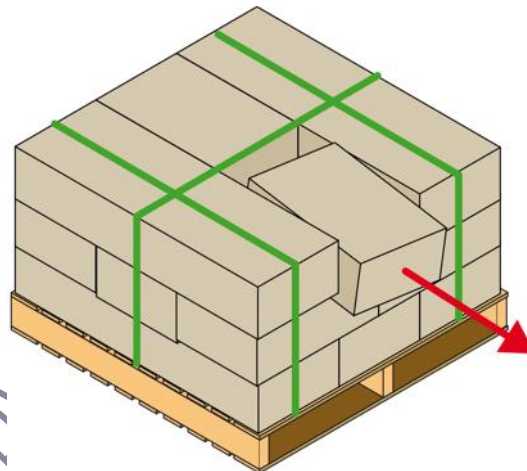

7.4 Pantechs

In the case of pantechs:

- If the load is 100% full (that is, a load **not** defined by Section 7.1 above), then the load does not need to be restrained separately.
- If the load is less than 100% full – then Section 7.1 applies.
- When loading freight into pantechs, make sure there is even weight distribution both across the width and preferably along the length of the container.



- Pack loads tightly within pantechs to prevent the load from moving sideways or horizontally.
- Only use shoring/blocking bars to stabilise loads because they have limited load restraint capacity. Rated bars may be suitable for blocking some loads.

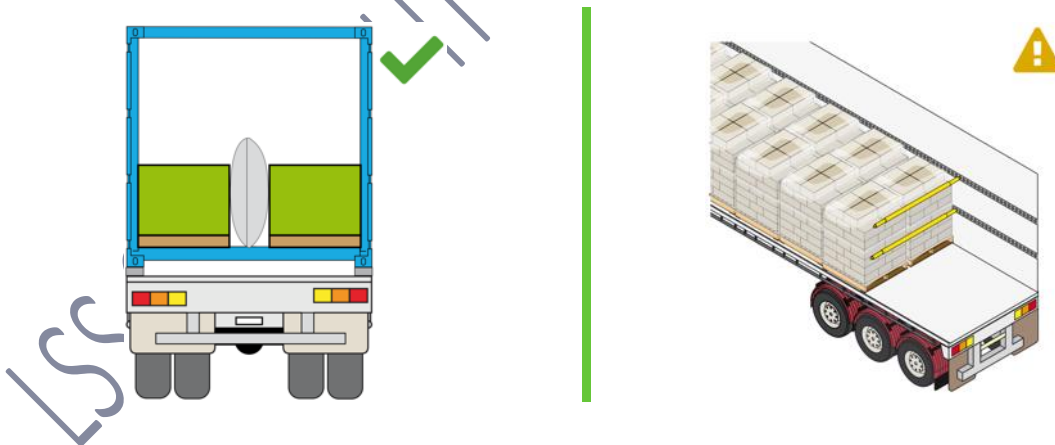

7.5 Intermediate Bulk Containers (IBCs)

Intermediate bulk containers (IBCs) are reusable industrial containers designed to transport and store bulk liquids.

General Tips

Place IBCs that have low-friction bases on timber or rubber surfaces to improve friction.

Block IBCs in the forward direction wherever possible to reduce the required number of tie-down lashings.

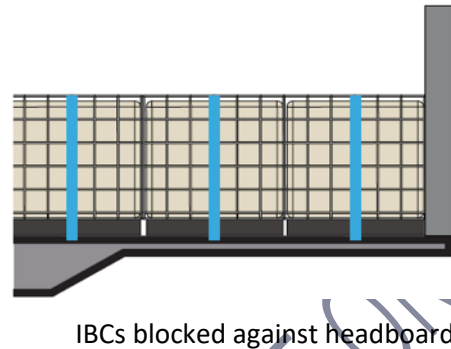
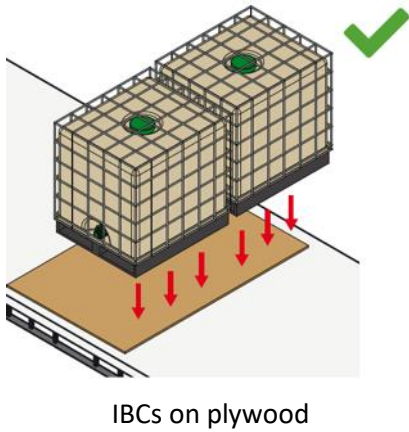

Where a suitably engineered blocking surface is not available, use crossover straps to block the load or use empty pallets tied down to fill gaps in the load.

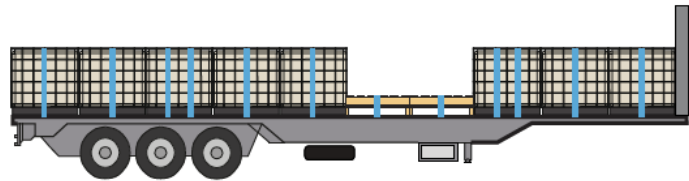
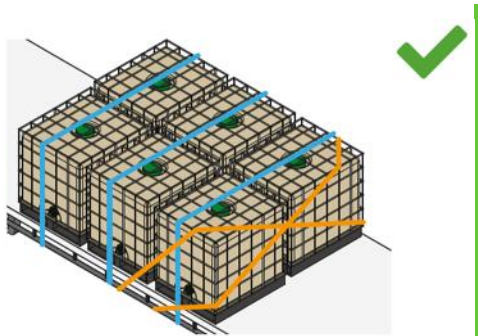

7.6 Bulk bags

Bulk bags are industrial containers made of flexible fabrics. They are used to transport powdered and granular materials. The guidelines below set out how you can meet the Performance Standards when restraining bulk bags.

General Tips

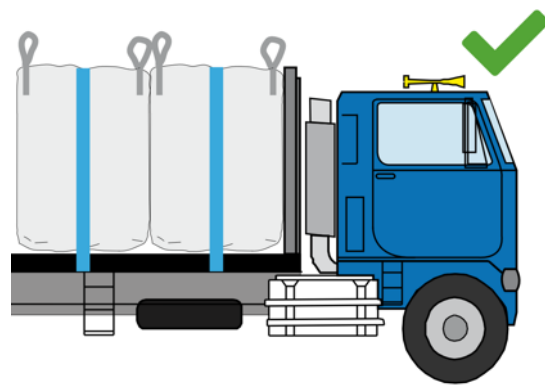
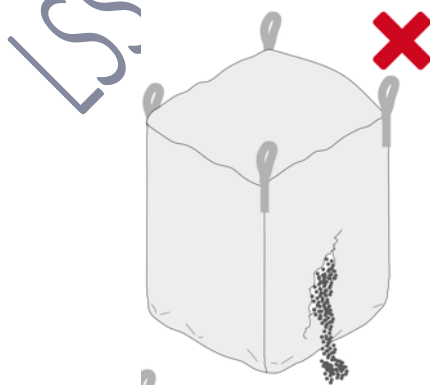

Make sure bulk bags are in good condition and free of cuts and tears

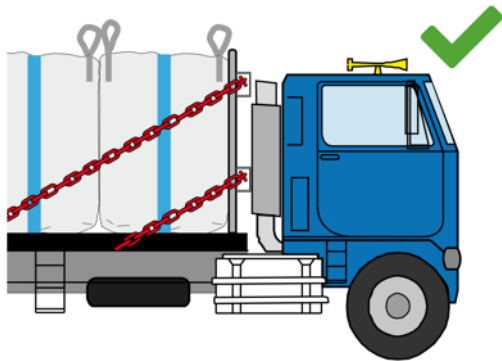

Load bulk bags in groups without gaps and block in the forwards direction

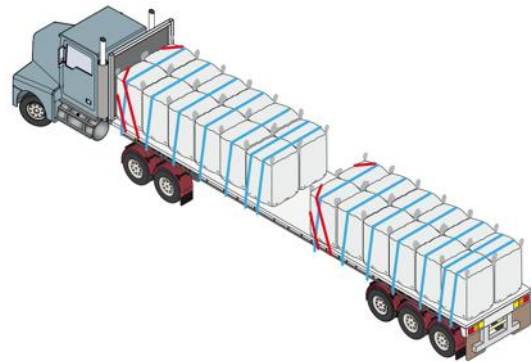

Reinforce unrated blocking surfaces using chains (or similar) wrapped across the face of the blocking surface

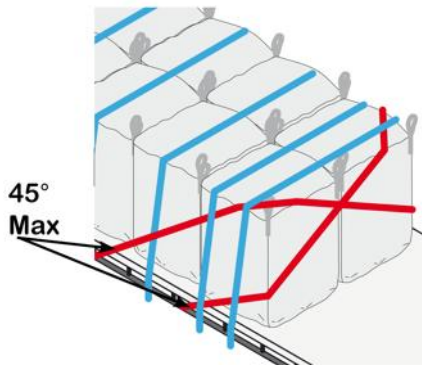

Split full loads into multiple groups to reduce the load on each blocking surface

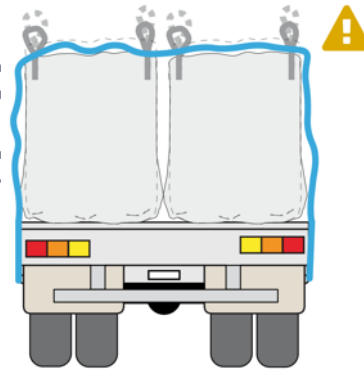

Where a suitably engineered blocking surface is not available, block bags with crossover straps angled at a maximum of 45° to the horizontal

Check lashing tensions at regular intervals during transport and re-tighten as required.

Load restraint of bulk bags on pallets is the same as for palletised freight.

7.7 Drums

Drums transported vertically must be restrained by tie down and forward blocking. Restrain every drum with at least one lashing, unless they are unitised to a pallet.

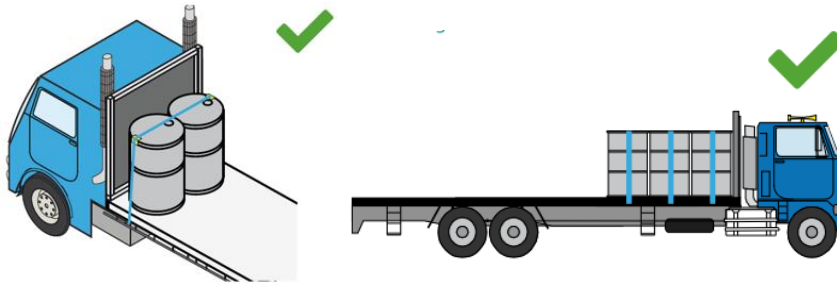

General Tips

- Drum restraint by be aided if drums are adequately supported by surrounding product
- Drums can be restrained against headboards by tie-down or opposed loops
- Do not use tarpaulin or curtain sides as the sole form of restraint
- Anti-slip rubber can reduce the lashing for required
- Angled edge corner protectors can prevent damage and also prevent lashings from slipping

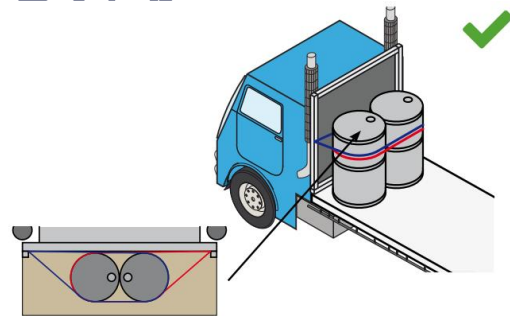
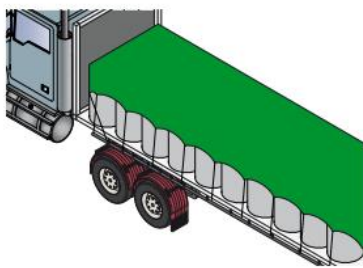
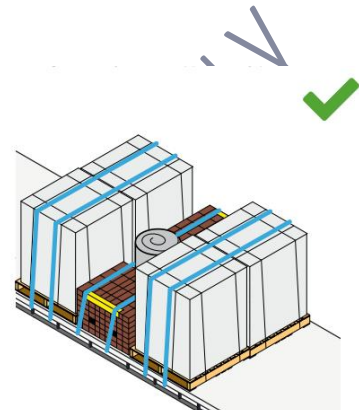

7.8 Bags and Sacks

Bags and sacks can be contained within rated gates or curtains, and should be transported on unitised pallets wherever possible

Loose bags and sacks may also be transported within stillages, provided stillages are restrained as per Section 7.9

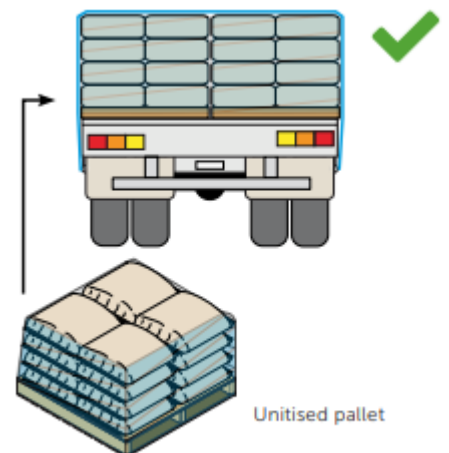

7.9 Stillages and transport frames

Stillages are designed to contain and transport loads made up of lots of loose pieces to simplify the restraint requirements. Transport frames include steel based stillages, palletcons and bins.

General Tips

Place stillages or transport frames that have low-friction bases on timber or rubber surfaces to improve friction.

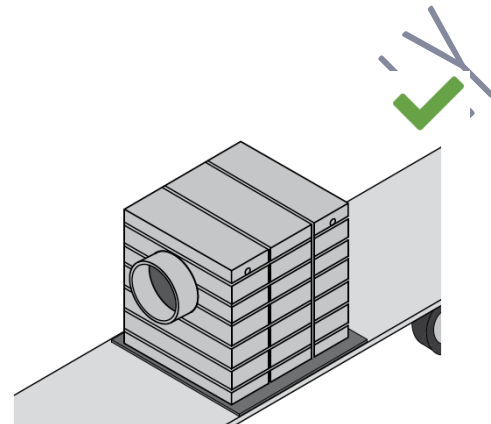
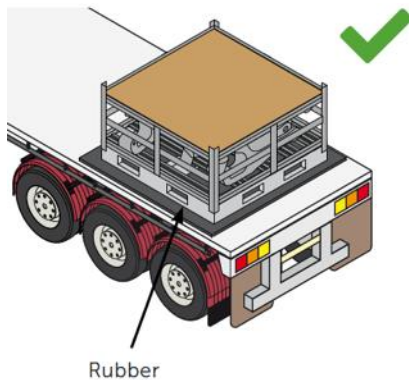

Block stillages and transport frames in the forward direction wherever possible to reduce the required number of tie-down lashings. Where a suitably engineered blocking surface is not available, use crossover lashings to block the load.

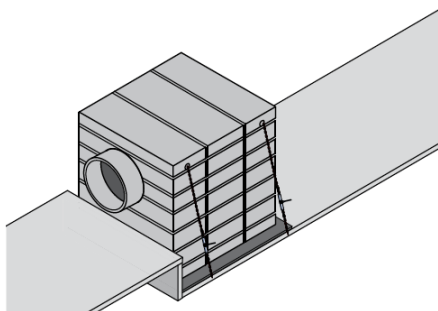

Blocked to front

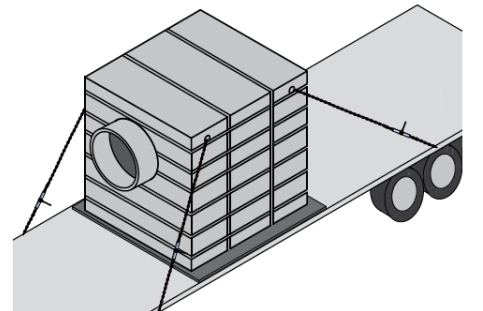

Direct restraint

Only use stillages and transport frames that are suitably engineered and capable of restraining all items placed within them when subjected to the Performance Standard forces.

Make sure stillages adequately restrict the upward movement of items they contain to prevent them from dislodging or are deep enough to securely contain the freight.

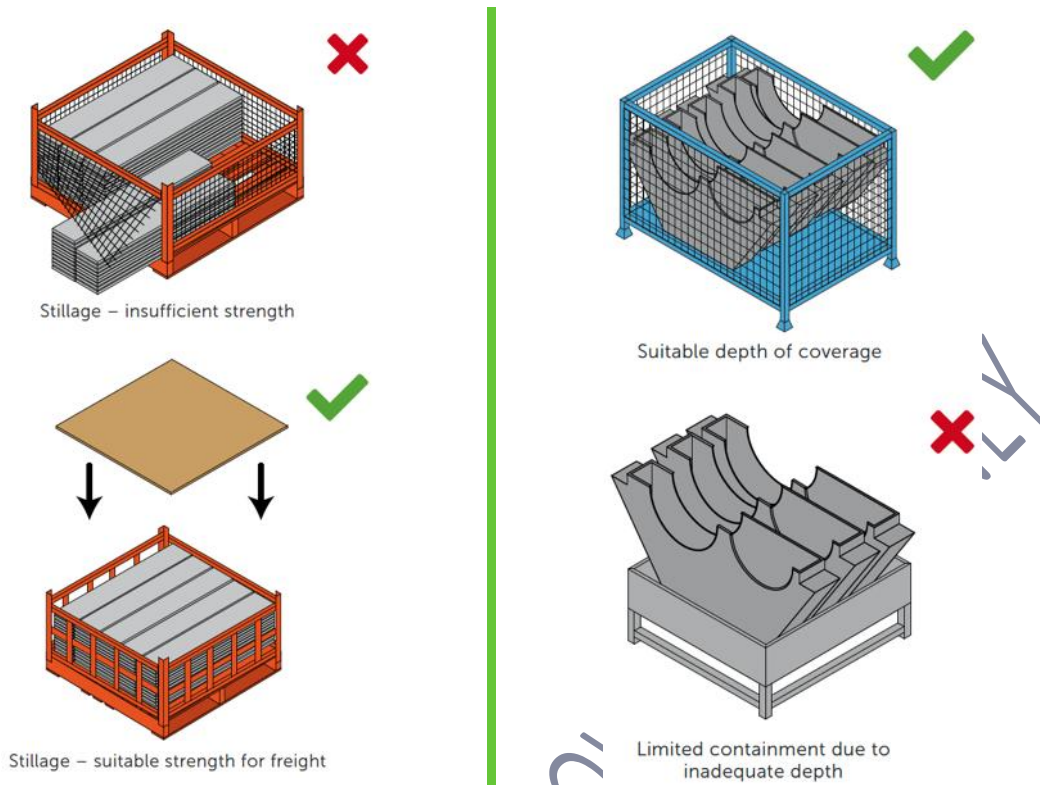

7.10 Contained Loads

Contained loads include loads transported in containers, drop-sided vehicles, pantechicon and curtain-sided vehicles, flattop vehicles with gates, and tankers. The guidelines below set out how you can meet the Performance Standards when restraining contained loads. They are intended to be used as a guide only. You can restrain using other methods. It is recommended that an engineer certifies alternative methods.

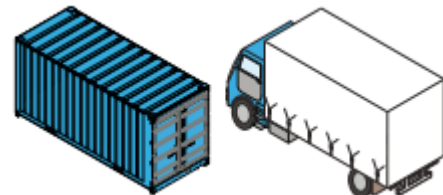

- Pack loads tightly within the vehicle body and sides to prevent the load from moving sideways or forwards or backwards
- Fill gaps with empty pallets, dunnage, foam or other suitable materials.
- Do not leave gaps unblocked in contained loads as freight can move during transport
- Where tight packing is not possible, the total of all gap widths in any direction must be less than 200 mm front to back and 100 mm side to side

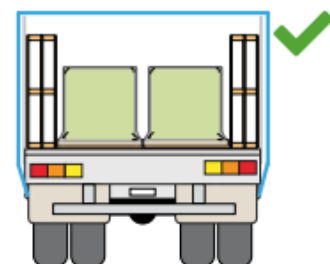

7.11 Containerised freight

When loading freight into containers, make sure there is even weight distribution both across the width and preferably along the length of the container.

Uneven weight distribution may affect the stability of the carrying vehicle.

Consignors should advise drivers how a containerised load is packed so that they can understand the impact of the load on the vehicle's stability and drive accordingly.

- Load light freight on top of heavy freight to lower the centre of gravity and increase vehicle stability
- Ensure any small or loose items placed on top of larger freight should be adequately restrained to prevent movement in transit
- Palletised freight must NOT be double stacked unless the upper pallet is able to be positioned on a flat stable surface, freight is adequately unitised to the pallet, and the cargo is restrained and unable to move during transit
- Do not exceed the manufacturer specified maximum allowable load mass of the container or vehicle
- Fill gaps with empty pallets, dunnage, foam, custom framing or other suitable materials.
- Use rated inflatable dunnage as part of restraint systems within containers
- Do not use inflatable dunnage to restrain sharp objects
- Do not leave gaps unblocked in containerised loads because freight may move during transport and impact the container walls
- Use lashings, webbing nets or gates to prevent loads that may have shifted during transport from falling out when the doors are opened



It is important to ensure the container itself is sound and fit for purpose.

- Ensure the container frame and walls are not buckled or bent
- Ensure container doors and door closure mechanisms are undamaged and securely fastened
- Ensure that all container locks are correctly engaged

7.11.1 Loading transportable chemical tanks into containers

- Use a wooden pallet at the rear of the container to block the load
- Use anti slip matting along the floor of the container
- Strap each tank using tie down points within the container
- Use airbags as dunnage to prevent side to side movement
- Block the rear of the container with pallets



7.12 Bladders, liners and flexible tanks

Product contained within bladders, liners and flexible tanks can be transported inside rigid containers

Always consider product movement and its effect on the carrying vehicle's stability

Ensure container walls are rated to restrain the full specified payload and/or liquid surge forces

Flexible tanks in containers often have a high centre of mass, which can reduce vehicle stability

Ensure the bladder, tank or liner is secured at the rear of the container, by straps or metal bars to ensure container doors can be opened safely

If the container is to be tipped when unloading, the restraint system must be sufficient to contain the load both when fully loaded and during the tipping process where the container may reach a tipping angle of up to 38 degrees.

The liner and bulkhead must be of sufficient strength, fit for purpose and secured within the container

The left hand container door is to remain closed during tipping operations for added restraint.



7.13 Bulk loads

Loose bulk loads include coal and coal ash, for transport to and from production facilities.

Bulk Loads may also include bulk liquid products, which may be transported in bulk tanker vehicles, or via isotainer.

General Tips

Loose Bulk Loads

- Loose bulk loads carted in tippers must be contained with rated load covers
- Heavier bulk loads may require load nets or tarpaulins

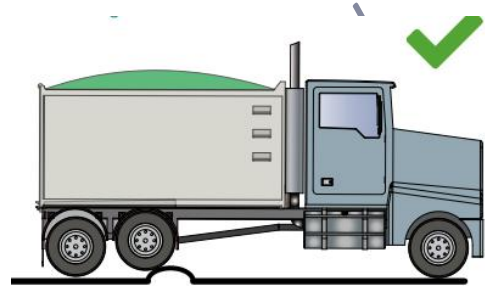

Liquid Loads

- Liquid loads must be transported in fully sealed bodies to prevent leaking
- Tankers should have baffles or compartments to minimise liquid slosh, which may affect the vehicles stability
- Partially filled tankers are prone to sideways liquid movement which may affect vehicle stability
- For any liquid carried in an unbaffled compartment of 7500L or greater capacity, in order to maximise vehicle stability, the liquid volume within the container must be less than 20%, or greater than 80% of the compartment capacity

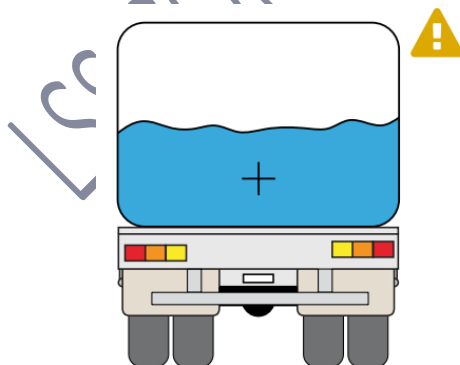
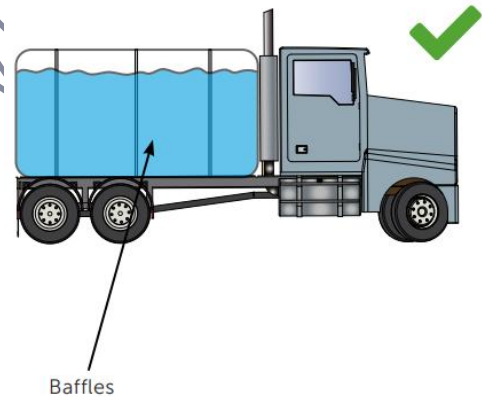

Part-filled tank

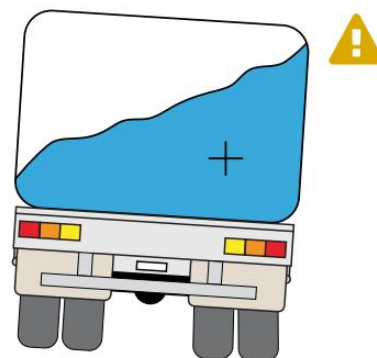

Sideways liquid movement

7.14 Machinery and Equipment

Machinery and equipment must be restrained in accordance with the Performance standards, and restraint requirements will vary dependant on the equipment being moved.

Ensure all equipment lashing points are used in accordance with the manufactures instructions and are of sufficient strength to adequately restrain the load.

General tips

- Be aware of manufacturers loading and restraint recommendations, and any lashing points fitted to the equipment.
- Loop chains around suitable parts of the load for restraint, such as designated lifting or lashing points
- Ensure sufficient clamping is provided to the restrained object when using looped lashings
- Loop chains have the potential to damage fragile components or work loose if components move or deform during transport
- If chain is positioned over a sharp edge, use suitable corner protectors or reposition the chain
- Chains applied over a sharp edge will not perform at their rated capacity
- Manufacturer lashing points should be clearly identified, and have their restraint capacity specified
- Do not use lifting lugs as lashing points if they are unsuitable for the chosen load restraint method
- Restrain any part of the equipment that can move or rotate
- Utilise dunnage, rubber matting or timber decking to aid load restraint

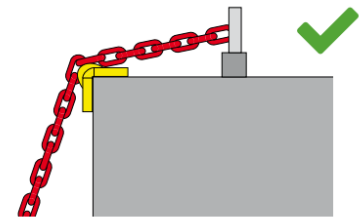
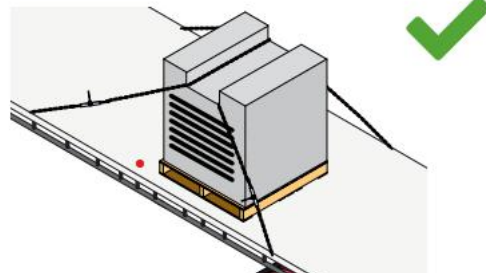

Figure 260 Straight line pull



7.15 Vehicles and Mobile Equipment

Vehicles and mobile equipment includes rubber-tyred, steel-wheeled or tracked vehicles and mobile equipment. The guidelines below set out how you can meet the Performance Standards when restraining vehicles and mobile equipment. They are intended to be used as a guide only. You can restrain using other methods. It is recommended that an engineer certifies alternative methods.

Check for the manufacturer's loading and restraint recommendations and the lashing points fitted to the vehicle/mobile equipment by the manufacturer. Ensure manufacturer-supplied recommendations are compliant with Australian (or ISO) load restraint regulations.

- Small vehicles and mobile equipment can be transported on general freight vehicles
- Restrain small equipment such as mowers, skid-steer loaders, etc. by direct lashings or containment.
- Transport large/tall vehicles and mobile equipment on low loaders to increase vehicle stability
- Restrain vehicles and mobile equipment by direct lashings and/or blocking wherever possible. Lashings should be of the same type, same length and equivalent angles to work together
- Restrain any part of the equipment that can move or rotate
- Directly restrain rubber-tyred vehicles and equipment in the forward and rearward direction, wherever possible.
- Make sure the vehicle/equipment's tyres are always in contact with the deck.
- Do not use tie-down restraint for equipment on metal tracks because there is not enough friction to adequately restrain it
- Do not rely on brakes to prevent wheels rotating.
- Make sure lashings attached to axles or wheels do not damage brake pipes, hoses, anti-lock brake sensors or other components

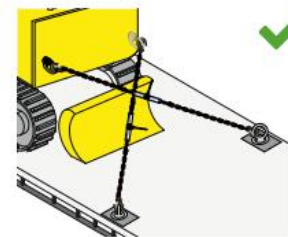
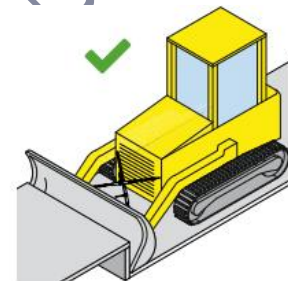
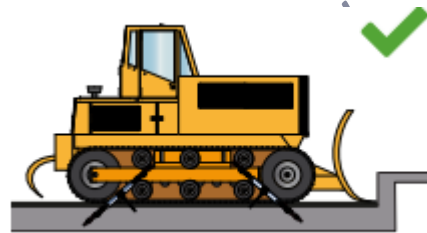

LSS COPYRIGHT - APPROVED

7.16 Dangerous Goods

Loads of Dangerous Goods must be restrained as required by the Performance Standards, and as set out in the Australian Code for the Transport of Dangerous Goods by Road & Rail.

Consignors, loaders, drivers and operators involved in the transport of bulk and packaged dangerous goods must be familiar with the code.

Dangerous Goods class labels indicate class type of the product being transport. Refer to the Australian Code for the Transport of Dangerous Goods by Road & Rail for load restraint requirements specific to the class of Dangerous Goods being transported.



LSS COPYRIGHT - APPROVED U

8 Document control register

Document Date	Version No.	Clauses amended from previous Version	Approved by
2018-08	1		PG
2018-09-19	2	6.1, 6.2.3 – Reworded 6.3.2 – inclusion of 2 nd dot point and change to “may” in 3 rd 6.6 – Containers 6.9 – Bulk Bags 9 – Further information	PG
2019-02-26	3	9 – Additional clause	PG
2021-09-02	4	Renumbering Performance standards aligned to 3 rd edition load restraint guide Image updates Extension reformatting	AG
2022-11-11	5	Update to tie-down lashing Reference to HVNR for NTC guide	MB
2023-03-21	6	Additional clauses 7.2.6, 7.10, 7.11, 7.11.1, 7.12, 7.15, 7.16,	CW

9 Further Information

For further information about Australian load restraint legal requirements:

- Navigate to the website of the National Heavy Vehicle Regulator (NHVR) specifically to the dimension and loading area of <https://www.nhvr.gov.au/road-access/mass-dimension-and-loading/loading>
- To calculate the number of tie-down lashings required for a given load refer to the *Number of tie-down lashing tables* in the NTC Load Restraint Guide

This Guide should be read and used as a guide for safe restraint of loads within the Qenos supply chain. Supply chain parties with any further queries or issues about load restraint should consult with Qenos.